



ST-2X/4X/6X SQ
Owner's Manual

Before operating the unit, please read this manual thoroughly and retain it for future reference.

MISSION STATEMENT

Committed to Excellence

ZAPCO is dedicated to the pursuit of audio fidelity. Our prime objectives are to design and manufacture audio products of unsurpassed quality, to provide unparalleled support and service for these products and to conduct business in a manner that will enhance the quality of life for all involved.

Experience (Knowledge from doing)

There is absolutely no substitute for experience; that is a simple fact of life. Another simple fact is that ZAPCO has, for over forty years, been the leader in defining quality standards for the car audio industry.

These years of experience have led to a thorough understanding of the challenges that are unique to the world of car audio. ZAPCO's relentless quest for sonic purity consistently yields imaginative designs that utilize the most innovative technologies. The resulting products set the criteria by which all others in the industry are judged.

Table of Contents

A new level of Sound Quality	2
History of the Studio Series	2
The Studio-X SQ amplifiers	3
Main features of the Studio-X SQ amplifiers	3
Before you start your installation	4
Upgrading a Factory Stereo	4
Planning your power connections	5
Wire size	6
Mounting your Studio-X SQ amplifier	7
Inputs and Controls	8
ST-2X SQ Input Ends	8
ST-4X SQ Input Ends	9
ST-6X SQ Input Ends	10
Speaker Wiring of the Studio-X SQ Amplifiers	11
ST-2X SQ Speaker Wiring	11
ST-4X SQ Speaker Wiring	13
ST-6X SQ Speaker Wiring	15

A new level of Sound Quality

Zapco has a reputation for sound quality that is unsurpassed. It is our dedication to sonic purity and our passion for performance that built that reputation. With all the new amplifiers coming into the market, none has been any threat to Zapco's standing as the premiere amp and processor company for pure sound quality.

Just check out the audio competition scene. The pros know what to use to win. Competition amps however, do not come cheap, and not everyone wants to compete. The challenge then, was to put Zapco's 40 plus years of experience to use in the development of an amplifier that would bring Zapco sound a line of products for every-day use and that everyone could afford. And the studio line is just that amplifier. In the time it has been out it has built a reputation as the best sounding amp in the class.

Of course, not everyone buys strictly by sound (although they should). Maybe it's the wrong color, maybe it's too big... or too small. But one thing is constant. Everyone who hears the studio amps agrees; it sounds better than any other product in the class.

History of the Studio Series

Perfection cannot be achieved. But that does not make its pursuit less valuable. Zapco is committed to making every product we make better than the last. We introduced the ST-X amps in 2013. In 2015 we improved the PCB design and upgraded components to make the sonically improved ST-X II.

Last year we began development of the Studio X SQ amplifier to take affordable sound quality to a new level. We added the proprietary RCA connectors from the Z-LX amplifiers, changed the capacitors to a higher end audio cap, and made a few other small changes. All this takes take the Studio sound to a new level of sonic performance for an affordable amplifier.

The Studio-X SQ Amplifiers

With the new Studio X SQ you get the sound quality that other companies offer only in their big competition amps (and better than many of them) in a compact chassis with 65W RMS/Channel @ 4Ω and 95W RMS/channel @ 2Ω (100W/Ch. @ 4Ω and 150W/Ch. @ 2Ω for the ST-6X SQ). You also get plenty of features, like 12dB/octave multi-function crossovers, bass boost, variable gain and even pass-through RCA outputs so you can daisy chain amps.

As for performance, the Studio X SQ give you more than power. These amps have 0.2% THD+noise, over 90dB signal to noise, over 60dB separation, and produce power from 15Hz to 30kHz.



Tiffany style Panel Mount RCA

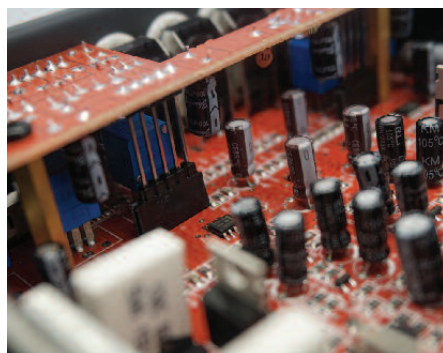

SQ Upgrades: Op-amps, Caps, Etc.

Main features of the Studio-X SQ amplifiers

- Full Range, Class A/B
- SQ Upgrades: Op-amps, Caps, Etc.
- Tiffany style Panel Mount RCA
- RCA and Speaker Level Inputs
- Variable input gain control
- Variable electronic crossover
- Auto-on with Speaker level inputs
- Variable bass boost control
- THD @ Rated Power < 0.5%
- Signal to Noise Ratio > 90dB
- Channel Separation > 60dB
- 65 watts/Ch. 4Ω (100 watts, ST-6X SQ)
- 95 watts/Ch. 2Ω (150 watts, ST-6X SQ)
- Frequency Response 15Hz to 30KHz ±1dB
- ST-2X SQ Dimensions:
Chassis 160(W) x 52(H) x 154(L)
Overall 160(W) x 52(H) x 180(L)
- ST-4X SQ Dimensions:
Chassis 160(W) x 52(H) x 282(L)
Overall 160(W) x 52(H) x 320(L)
- ST-6X SQ Dimensions:
Chassis 160(W) x 52(H) x 452(L)
Overall 160(W) x 52(H) x 488(L)

Before you start your installation

ZAPCO highly recommends that a fuse or circuit breaker be placed within 18" of the battery. Although you will add a fuse or fuse block near the amplifier it is still a possibility that a pinched power wire between the component fuse and the battery could result in a short, or even a fire. The protection device should be placed where it can be accessed easily and all wiring should be routed safely and correctly according to the following guidelines:

Do not run wiring close to hot or spinning objects.

Always use wire grommets when routing wire through the firewall or any other metal panels.

Make sure that the potential for pinched wiring is avoided by routing all wires away from moving hinges and seats. This also includes brake, gas and clutch pedals, hood and trunk hinges, etc.

Continuous exposure to excessive sound pressure levels may cause permanent hearing loss. ZAPCO strongly advises that you use common sense when setting volume levels. If you experience ringing in the ears, it could cause permanent hearing damage!

When connecting our amplifiers to pre-wired stock speakers, care must be taken that there are no common connections between left and right speaker wires, i.e. two or more speakers using the same ground connection (very common in pre-85 cars), as this will cause the amplifier to go into immediate protection or may cause damage to the amplifier. Output connections are not common chassis ground. Please follow the hookup instructions in this owner's manual. Any questions should be directed to your local ZAPCO dealer.

Upgrading a Factory Stereo

If you are upgrading a factory stereo the ST-X SQ amps have a separate speaker level input plug that senses current, so you do not need to run a turn-on wire. However, auto-on is not useful in all cars as the amplifier can come on when you do not want it on, because of the car's electrical system. The ST-X SQ amps have a switch that allows you to defeat the auto-on if you find you do not want to use that function.

Planning your power connections

The power end plates of the Zapco ST-X SQ amplifiers carry the power connections and the speaker connections and vary somewhat by the number of channels. For example, the power end of the ST-4X SQ below has (of course) speaker connections for four channels. The ST-X SQ amps all have on-board fuses and the fuse rating as printed above the fuses. The main 12-volt power input, the 12-volt turn-on wire, and the main Ground connection are common to both models.

- The large connection at the interior of the end plate is the main power input. This must be connected the vehicle battery's positive (+) terminal, and a main system fuse should be placed close to the battery
- The large connection at the outside of the end plate is the main ground or negative connection. This must be securely attached to bare metal at the vehicle frame, or other heavy chassis component with a direct connection to the frame

Note: Seat bolts and seat belt bolts are NOT good ground points

- The small terminal between the main power and ground is the +12 turn-on input and can be connected to the head unit turn-on output wire. If none is available it can be connected to an accessory (ACC) terminal. You should avoid using any ignition-on (IGN) wire, as they can be noisy

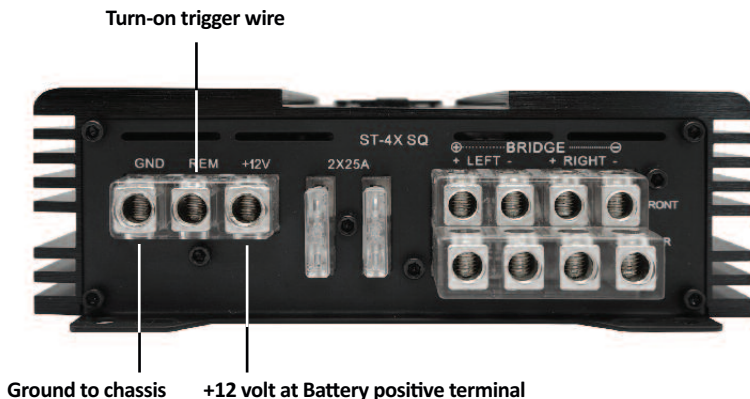

Note: The ST-X SQ amplifiers have terminals that do not require connectors. You simply insert a bare portion of wire and tighten the connection with the supplied Hex tool. As the wire conforms to the connector the connection can loosen. You should re-tighten the connection after about a week.

Some words about Power and Ground

Note: The second most common cause of underperforming amplifiers is insufficient power current or a poor power connection. The most common cause of underperforming amplifiers is insufficient ground current or a bad ground connection.

12-volt current: Battery Power works only if it travels in a complete circuit from the battery positive terminal to the battery negative terminal. Main power input, of course, is attached to the battery positive terminal. Ground current is returned to the battery through the chassis to the to the point where the battery is grounded.

The current available for your amplifier to use to produce power will be restricted by the smallest gauge of wire in the circuit and by the weakest physical connection in the circuit.

Wire Size

It's often surprising how many people will obsess about signal wire but routinely provide the amplifier with only a fraction of the current it needs to do its job. The most common wire gauge used in car audio is 10-gauge, and the most common location for amplifiers is in the trunk.

Wire Sizing Chart

	←----- Length of Run -----→							
	4 ft	7 ft	10 ft	13 ft	16 ft	19 ft	22 ft	28 ft
0-20 amps	14	12	12	10	10	8	8	8
20-35 amps	12	10	8	8	6	6	6	4
35-50 amps	10	8	8	6	6	4	4	4
50-60 amps	8	8	6	4	4	4	4	2
65-85 amps	6	6	4	4	2	2	2	0
85 -105amps	6	6	4	2	2	2	2	0
105-125 amps	4	4	4	2	2	0	0	0
125-150 amps	2	2	2	2	0	0	0	0

Let's look at a fairly small system. If you use a 50 watt/ch amp (25 amps) for the highs and a 100 watt/ch amp (40 amps) for the woofers, you need at least a 4-gauge and maybe a 2-Gauge wire to provide 65 amps at the trunk. Anything less and your car won't go boom. It'll just go Blap!

Note: It takes lots of current to make lots of power!

Remember! An electrical circuit is just that... a complete circuit. For current to travel, you must complete the circuit from the positive terminal to the negative terminal (which is connected to the vehicle frame). So what ever Gauge wire you use for power (B+) you must also use for ground (B-).

Note: A 4-gauge power wire needs 4-gauge ground wire!

Use the Wire Sizing Chart! Add up the fuse values on the amplifier(s) then choose the proper size wire based on the distance from the car battery to the amplifier location. Again, always use the same gauge wire for the main ground as you do for the main power. Always make your ground as short as possible and secure it to a clean solid surface, preferably the vehicle frame.

Mounting your ST-X SQ amplifier

Mounting your Zapco amplifier is easy. Just keep in mind a few guidelines:

- The amplifier can be mounted in any direction, on wood, metal, or carpet
- The metal chassis of the amp can be grounded or left isolated
- The amplifier requires adequate ventilation. Creating power creates heat, and cooling requires air. Position the amplifier with sufficient surrounding area for air supply and keep the end plates clear for future access
- Keep the amplifier out of the engine compartment or other locations that may cause excessive heat or moisture
- Do not mount the amplifier to a subwoofer box or other place that may have excessive vibration

Setting Gains: Gain pots are not volume controls. Before you first turn on your system, you should make sure all gain controls are set to minimum. Gain controls should be used only if absolutely necessary. Turning up gain controls causes increased noise, makes distortion more likely and reduces the dynamic range of your system. If you head unit does not have sufficient output, you will get much better results by investing in a line driver to provide more signal to the amplifier.

ST-2X SQ Input/Controls Ends

The Input ends of the ST-X SQ amplifiers is where you find the signal input connectors, the pass through outputs, the crossover controls, bass boost control. For High Level (speaker level) you also find the port for the input plug and auto-on switch.

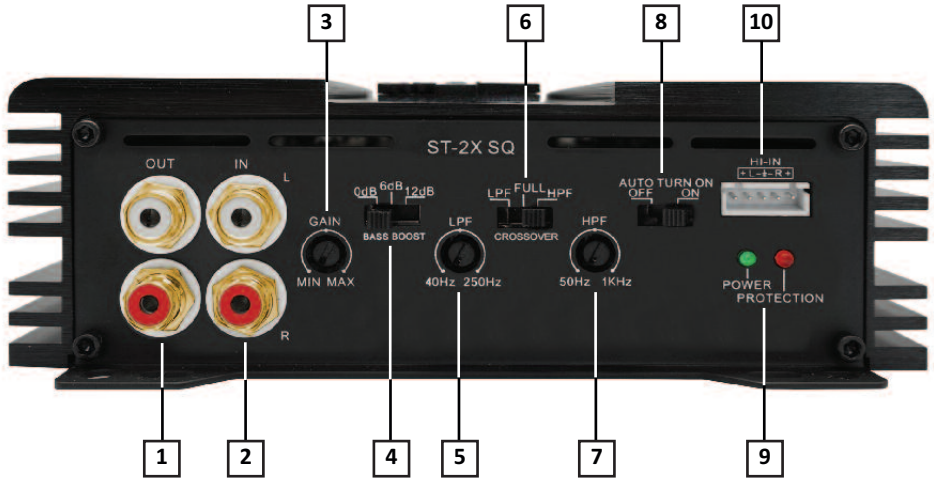

- 1• Pass through RCA output allows "daisy chaining" amplifiers
- 2• RCA inputs from an after-market head unit
- 3• Variable gain control (set to minimum before initial turn-on)
- 4• Bass boost switch for 0, 6dB, or 12dB
- 5• Low Pass frequency selector for the bass crossover

- 6• Crossover selector for low pass, full range, or high pass
- 7• High pass filter for the mids/highs
- 8• Auto-on switch for OEM integration
- 9• Green power-on LED and red protect LED
- 10• Speaker level input plug for OEM hookup. Note that black ground wire must be grounded, preferably the factory head unit or amplifier

OEM Speaker level Input plug

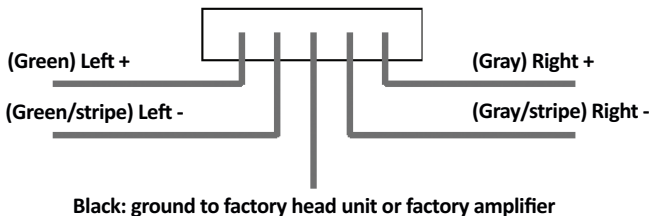

ST-4X SQ Input/Controls Ends

The ST-4X SQ has similar functions as the ST-2X SQ but the 4 channel layout puts the controls in different positions.

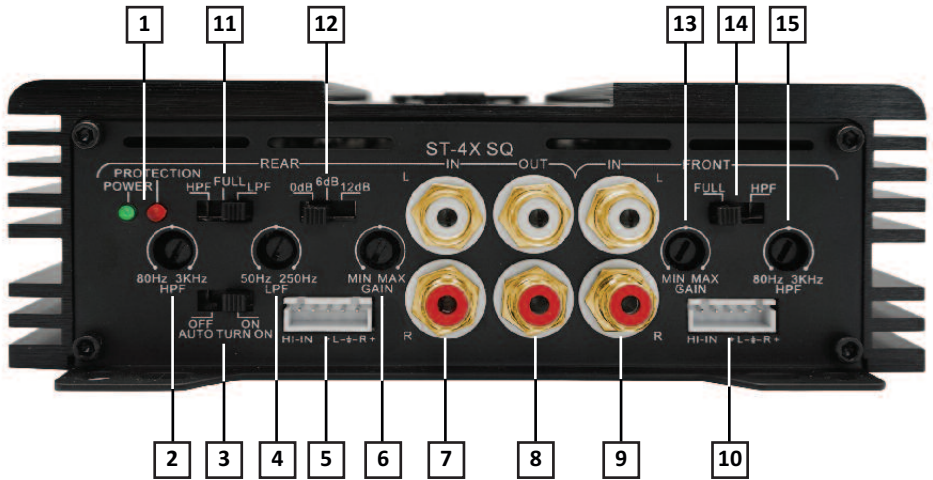

- 1• Green power-on LED and red protect LED
- 2• Rear High Pass frequency control
- 3• Auto-on switch for OEM integration
- 4• Rear Low Pass frequency control
- 5• Rear speaker level input plug for OEM hookup (See #10 of ST-2X SQ)*
- 6• Rear channels variable gain control
- 7• Rear channels RCA inputs
- 8• Pass through RCA output (rear channels can feed another amp)

- 9• Front channels RCA inputs
- 10• Front speaker level input plug for OEM hookup (See #10 of ST-2X SQ)*
- 11• Rear crossover function switch for high pass, full range, or low pass
- 12• Rear channels Bass Boost switch for 0, 6dB, or 12dB
- 13• Front channels variable gain control
- 14• Front crossover function selector for full range of high pass
- 15• Front High Pass frequency control

* See explanations of OEM Input plug on the previous section 2-Channel amp

ST-6X SQ Input/Controls Ends

The ST-6X SQ has similar functions as the other ST-X SQ amps but the 6 channel layout puts the controls in different positions. Plus the ST-6X SQ has a 2, 4, or 6ch. input mode selector and a remote control port.

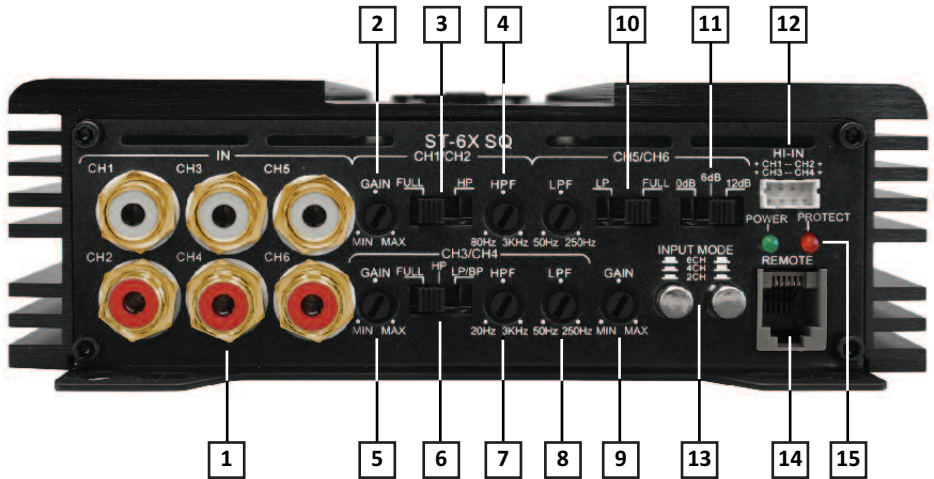

- 1• RCA inputs
- 2• Ch.1/2 variable gain control
- 3• Ch.1/2 crossover function selector for full range of high pass
- 4• Ch.1/2 High Pass frequency control
- 5• Ch.3/4 variable gain control
- 6• Ch.3/4 crossover function switch for high pass, full range, or low pass/band pass
- 7• Ch.3/4 High Pass frequency control
- 8• Ch.3/4 Low Pass frequency control
- 9• Ch.5/6 variable gain control
- 10• Ch.5/6 crossover function selector for low pass or full range
- 11• Ch.5/6 Bass Boost switch for 0, 6dB, or 12dB
- 12• Ch.1/4 speaker level input plug for OEM hookup (See #10 of ST-2X SQ)*
- 13• 2/4/6 Ch. input mode selector
- 14• Remote control port
- 15• Green power-on LED and red protect LED

* See explanations of OEM Input plug on the previous section 2-Channel amp

Speaker Wiring of the ST-X SQ Amplifiers

The Very Basics

- No speaker wires can be shorted to, or touching either ground or each other. This will put the amp into protect and may damage the amplifier
- When bridging the left and right channels of any ST-X SQ amplifier, you use the left channel (Ch1) positive and the right channel (Ch2) negative, as indicated on the chassis by the speaker terminals

ST-2X SQ Speaker Wiring

2Ch Stereo Mode

A simple 2 speaker hookup for a right and left stereo pair.

Note the basics above for speaker wiring and assure that + and - are connected correctly. A fuse should be added near the battery.

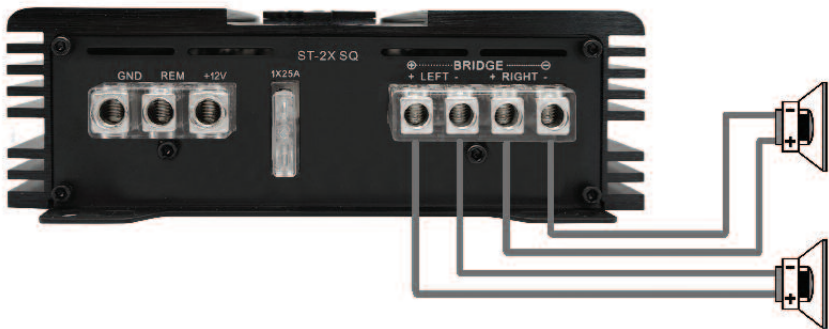

Single Channel Mode

This method is used most often to drive a mono woofer but can also be used to run separate amplifiers for the right and left channel.

- The ST-X amplifiers are stable to 2Ω stereo and 4Ω Mono so the single bridged speaker must be of 4Ω minimum impedance



3Ch Mode

It is possible to run the 2Ch amps in “3-Channel” mode by running a pair of speakers for the mids and highs on left and right channels, and at the same time run a woofer bridged between the L+ and R- terminals as shown. However, since each channel will see 1/2 the impedance of the woofer you must use a woofer of no less than 4Ω. The amplifier sees impedance by frequency, so you can have two 2Ω loads but you must use a passive crossover on each speaker in the three channel mode. With the crossovers in the line, the amplifier will always see a minimum load of 2Ω on each channel at all frequencies.

- Main speakers can be 2Ω~4Ω. Woofer can be 4Ω~8Ω but cannot be less than 4Ω (as in any bridged situation)
- The active amp crossovers are not used in this system

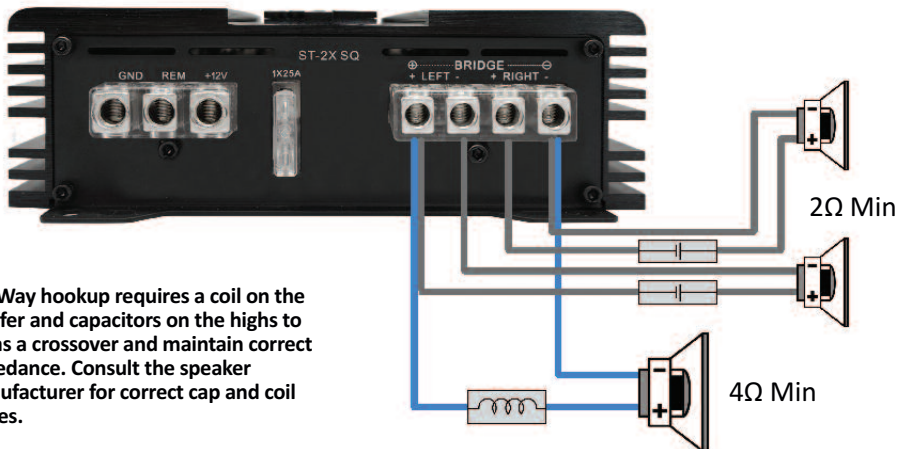

A 3-Way hookup requires a coil on the woofer and capacitors on the highs to act as a crossover and maintain correct impedance. Consult the speaker manufacturer for correct cap and coil values.

ST-4X SQ Speaker Wiring

4Ch Mode

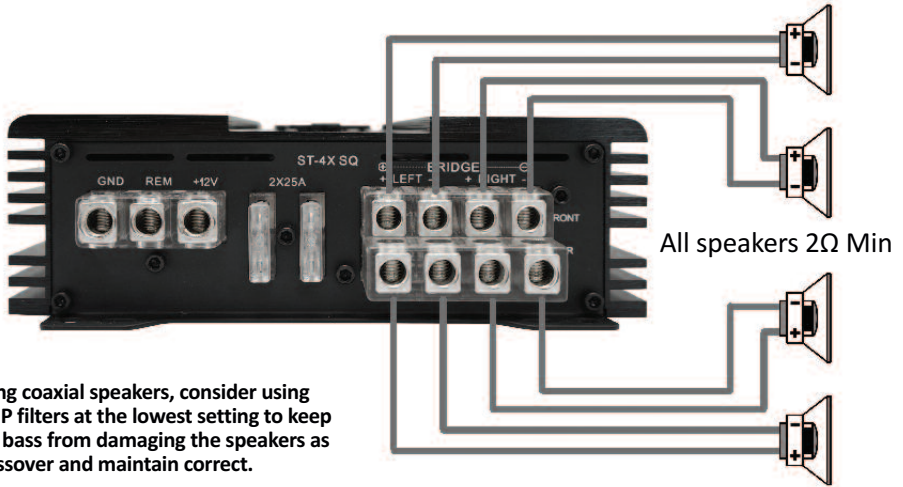

If using coaxial speakers, consider using the HP filters at the lowest setting to keep deep bass from damaging the speakers as a crossover and maintain correct.

High Power 2Ch Mode

Similar to bridging a stereo amp to a mono woofer, you can use the 4-Ch amp in a dual mono mode to create (in this case) a stereo amp with 190 watts RMS/ch. As with any bridged setup the speakers must be a minimum of 4Ω impedance. If you are using the active crossovers you should be sure that they are set to the same frequency

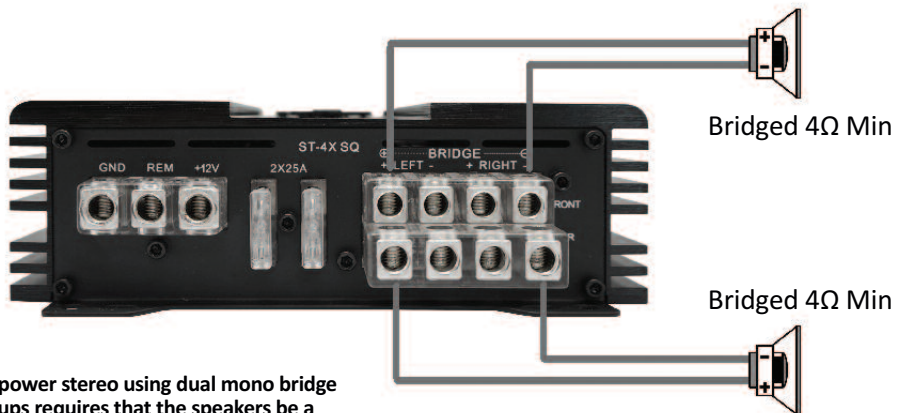

High power stereo using dual mono bridge hookups requires that the speakers be a minimum of 4 Ohms impedance each.

2-way Active System

Using the built-in active crossovers of the ST-4X SQ, you can easily create an active 2-way system with mid/highs on the front channels and bass on the rear channels. Below is an active system with a bridged subwoofer on the rear channels.

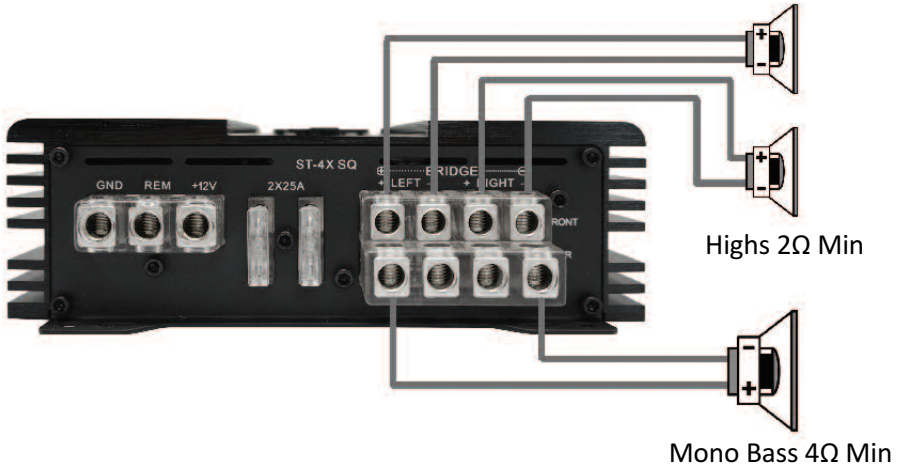

5Ch System

The 5-speakers system requires a passive crossover between the front highs and the mono woofer, with capacitors on the front highs positives and a coil on the woofer positive. All amplifiers channels are full range.

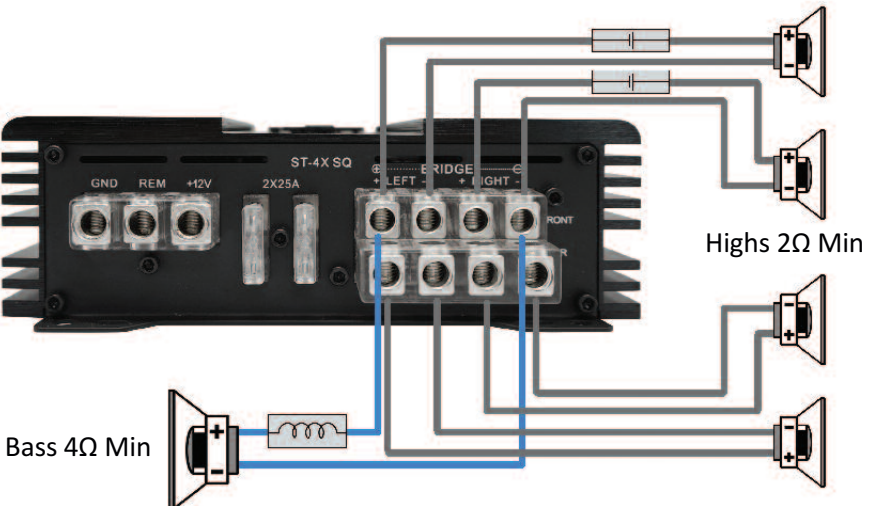

ST-6X SQ Speaker Wiring

2-way Active System

Below is a 2-way active system with a high power front stage. It gives 300 watts for each left and right front speaker plus 300 watts for the woofer or a high power center channel.

- Since all the channels are bridged, the speakers must all be 4Ω Minimum
- Ch1/2 and 3/4 will high passed just above the lowest recommended frequency for that speaker
- Ch 5/6 will be low passed (for a woofer) at the same frequency that 1/2 and 3/4 are high passed

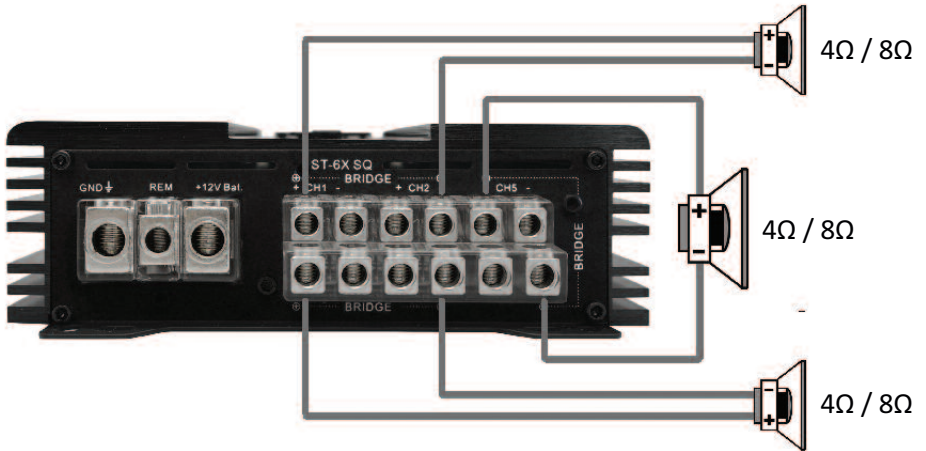

5Ch System

The most popular system for a six channel amplifier is right/left front, right/left rear, and a mono sub.

Note the hookup especially of the sub as Ch5+ and Ch6-. This give the sub the combined power of the 2 channels. Note that since the sub is a bridged hookup the sub must be 4Ω minimum.

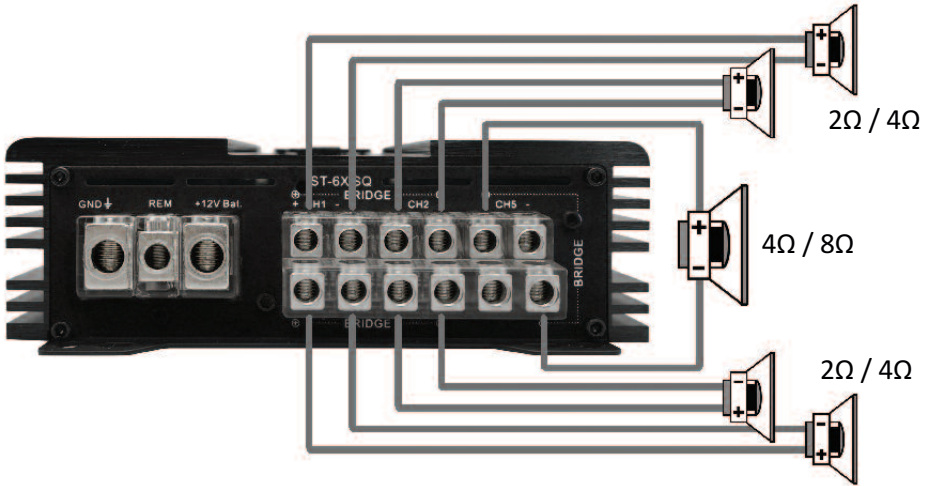

6Ch System

Below is a standard six speaker hookup for 3 pairs of right and left stereo speakers. Since each channel has one speaker, so each speaker can be 2Ω Minimum. Note the basics of speaker hookup and assure that + and - are connected correctly.

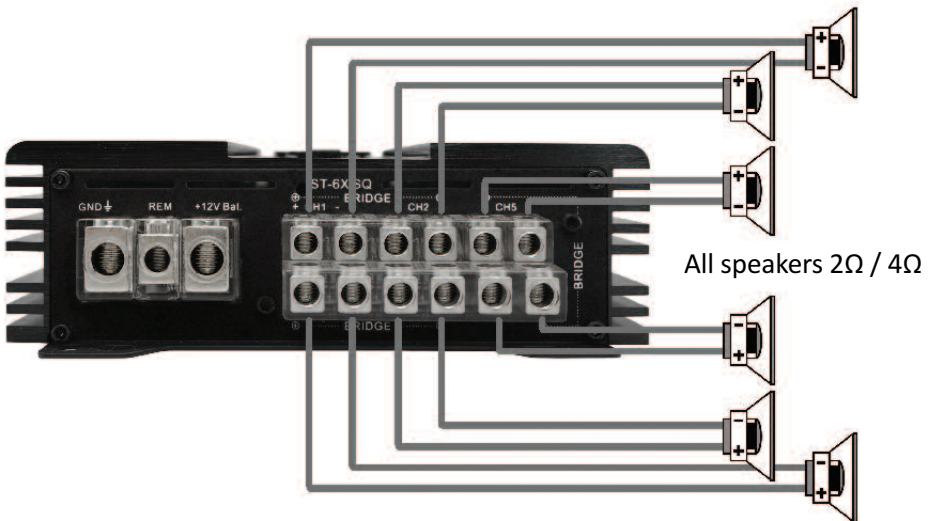



Modesto, California USA
Since 1974

zapco.com